

Thank you for purchasing our Calico Designs, Inc.

ARCH TOWER

Model #50500 Pewter/Teak

Model #50510 Silver/Black

Model #50520 Black/Cherry

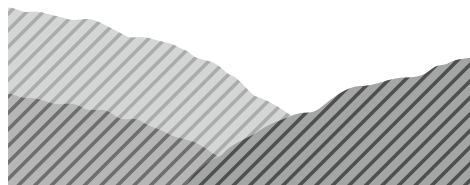
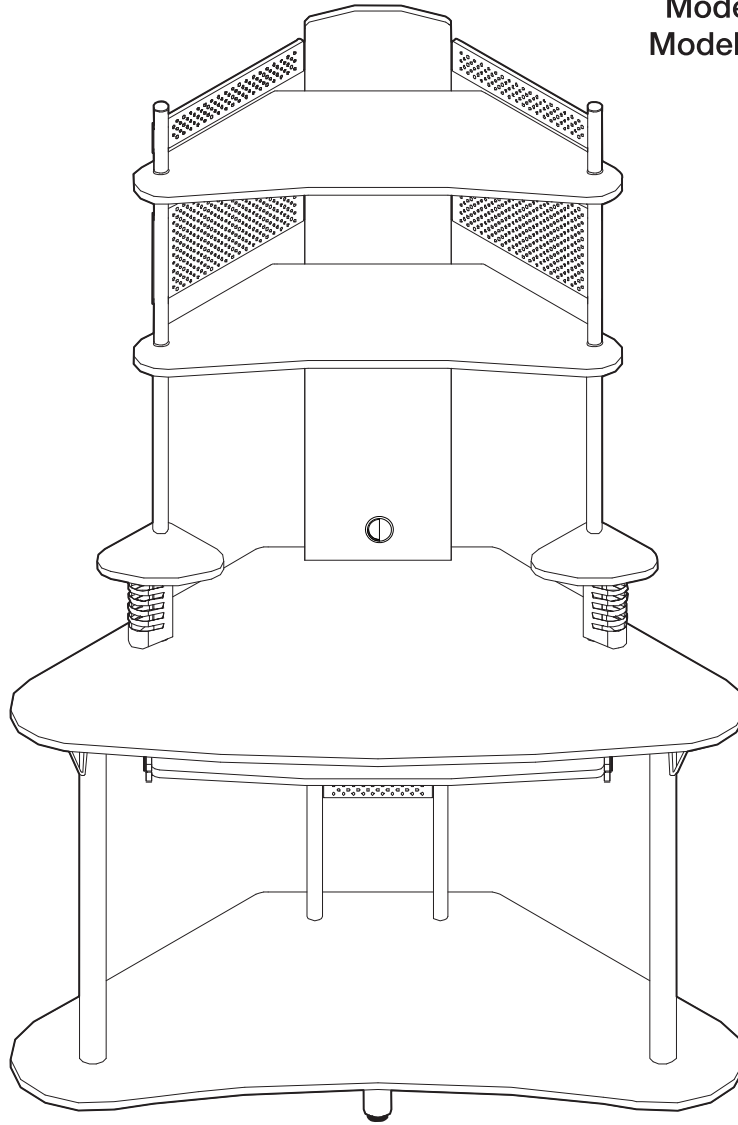

CALICO
DESIGNS

Product Support Line:

866.942.0492

Office: 562.942.0492

Rev. 08.06.2012

ASSEMBLY INSTRUCTIONS - IMPORTANT:

Carefully unpack & identify each component before attempting to assemble. Refer to parts list. Please take care when assembling the unit and always set the parts on a clean, soft surface.

If you require any assistance with assembly, parts, or information on other products, please visit our website: www.calico-designs.com or call or write us.

Additional Tool Required:

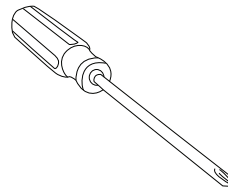

Check screws, nuts and bolts periodically (or every 3 months). Tighten if necessary.



WARNING: DO NOT USE POWER TOOLS



PARTS LIST

DESCRIPTION

QUANTITY

PICTURE

1. Main Top

1

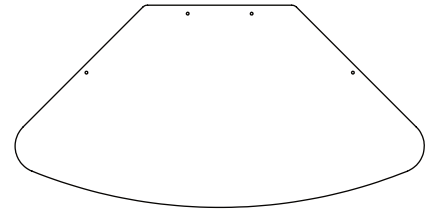

2. Bottom Shelf

1

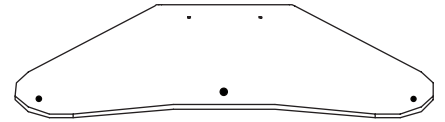

3. Top Shelf

2



4. Keyboard Shelf

1

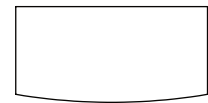

5. Rear Wood Panel

1

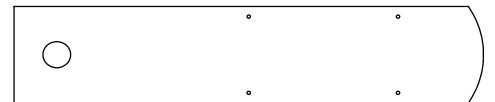

6. Speaker Shelf

2

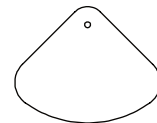

7. Front Leg



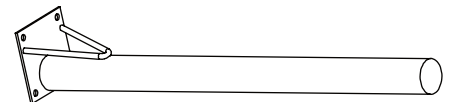

2

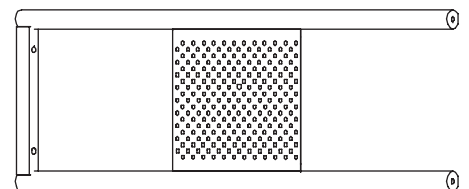

8. Rear Leg

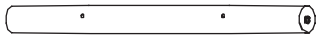
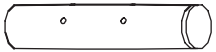
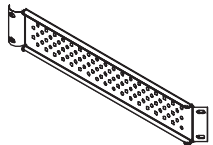
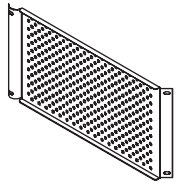
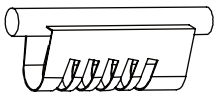
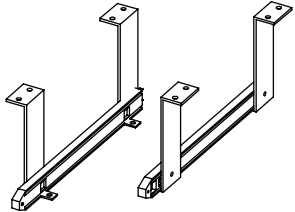
1

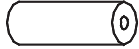

9.	Lower Shelf Tube	2	
10.	Upper Shelf Tube	2	
11.	Top Tube	2	
12.	Side Panel - Small	2	
13.	Side Panel - Large	2	
14.	CD Rack	2	
15.	Slider	2	
16.	Front Support Tube	3	
17.	Rear Support Tube	2	
18.	Cable Collar	1	

19. Small Allen Bolt 12

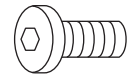

20. Large Allen Bolt 4

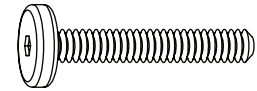

21. Allen Screw 6

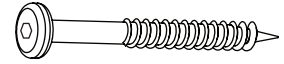

22. Connector Bolt - Large 10



23. Connector Bolt - Small 1

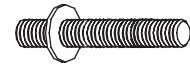

24. Phillips Screw 20



25. Floor Leveler 5

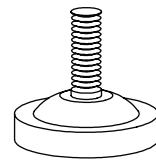

26. Allen Wrench 1

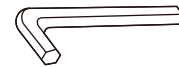

27. Plastic Spacer 6

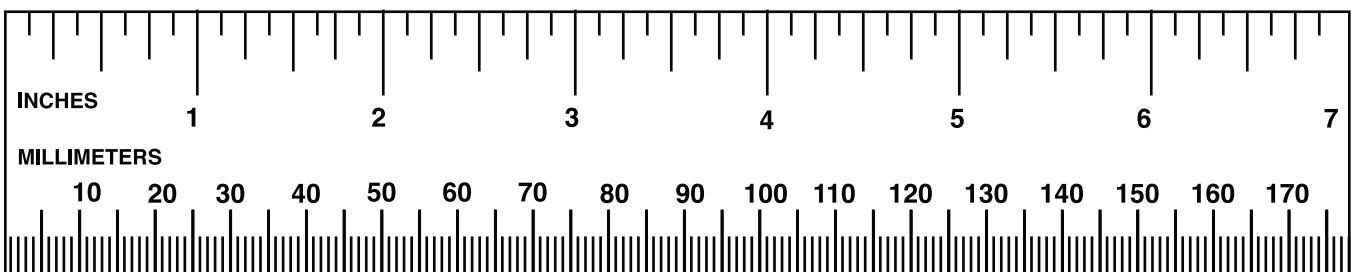
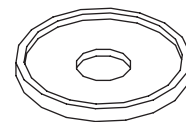

Step 1

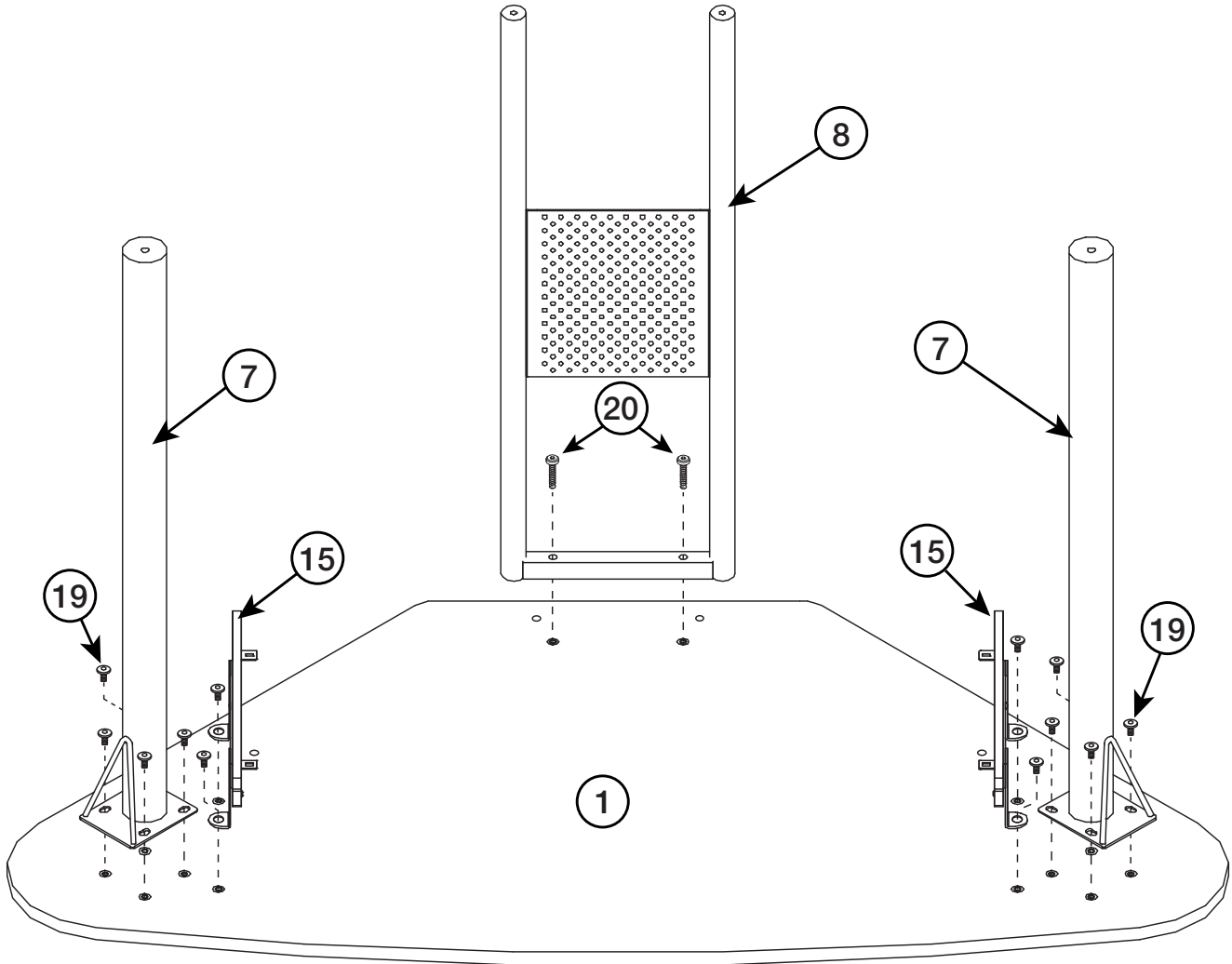

- Attach Front Legs (7) to bottom holes of Main Top (1) using Small Allen Bolts (19).
- Attach Rear Leg (8) to bottom holes of Main Top (1) using Large Allen Bolts (20).
- Attach Sliders (15) to bottom holes of Main Top (1) using Small Allen Bolts (19).

Step 2

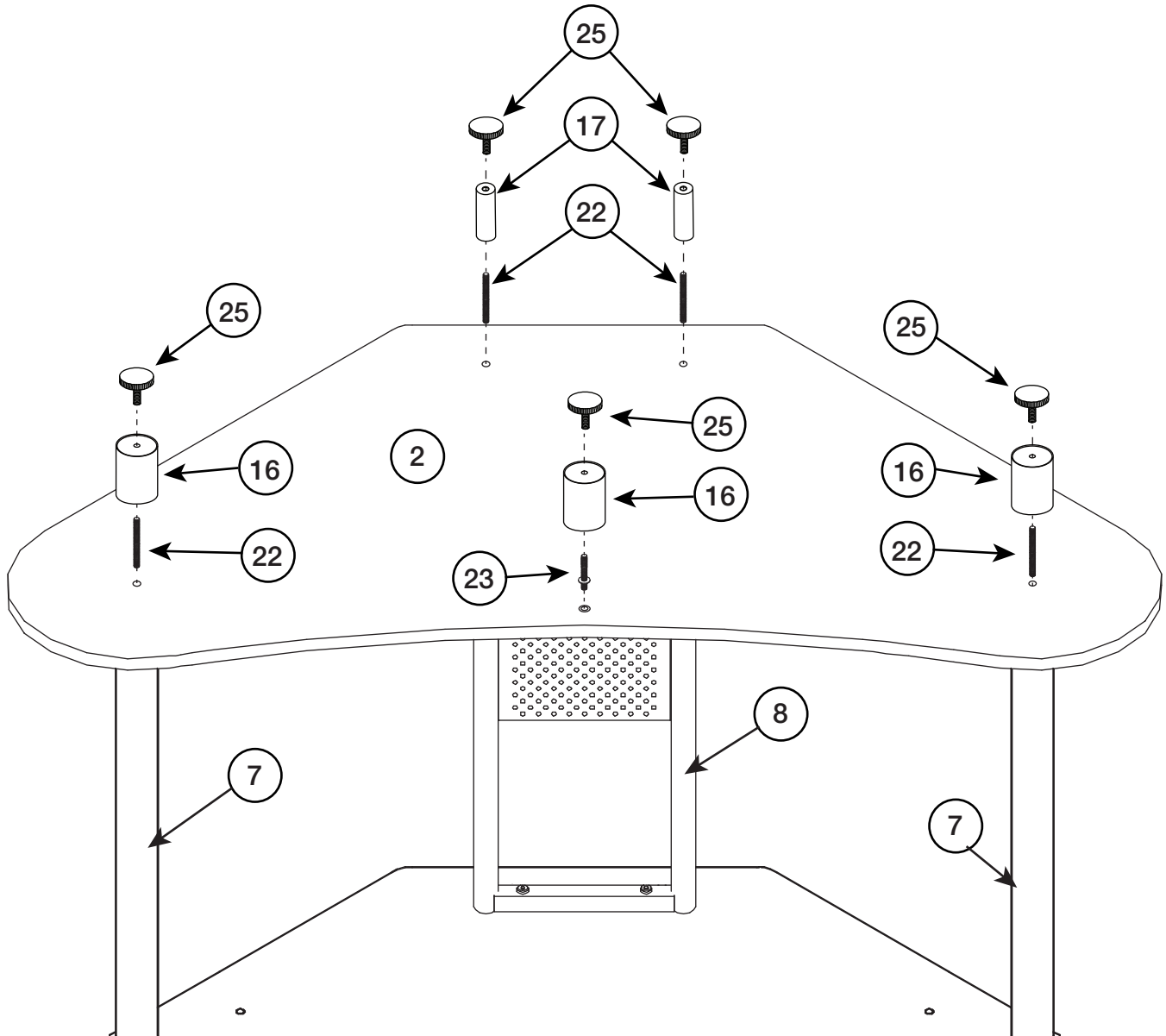

- Attach Bottom Shelf (2) to Front Legs (7) and Rear Leg (8) using Connector Bolt - Large (22), Connector Bolt - Small (23), Front Support Tube (16) and Rear Support Tube (17).
- Attach Floor Levelers (25) To Front Support Tubes (16) and Rear Support Tubes (17).

Step 3

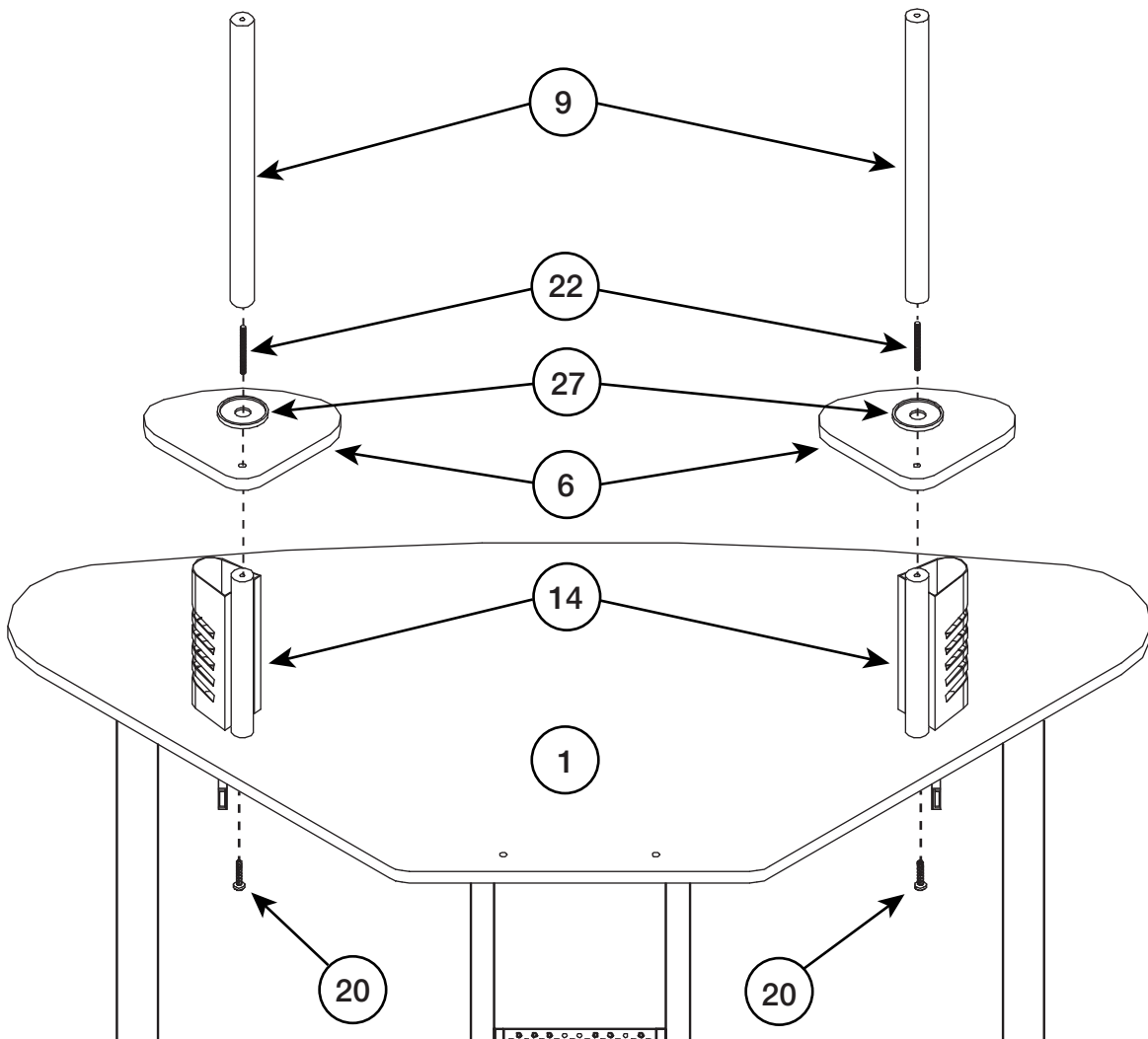

- Attach CD Rack (14), Speaker Shelf (6) and Lower Shelf Tube (9) to Main Top (1) using Large Allen Bolt (20), Connector Bolt - Large (22) and Plastic Spacer (27).

Step 4

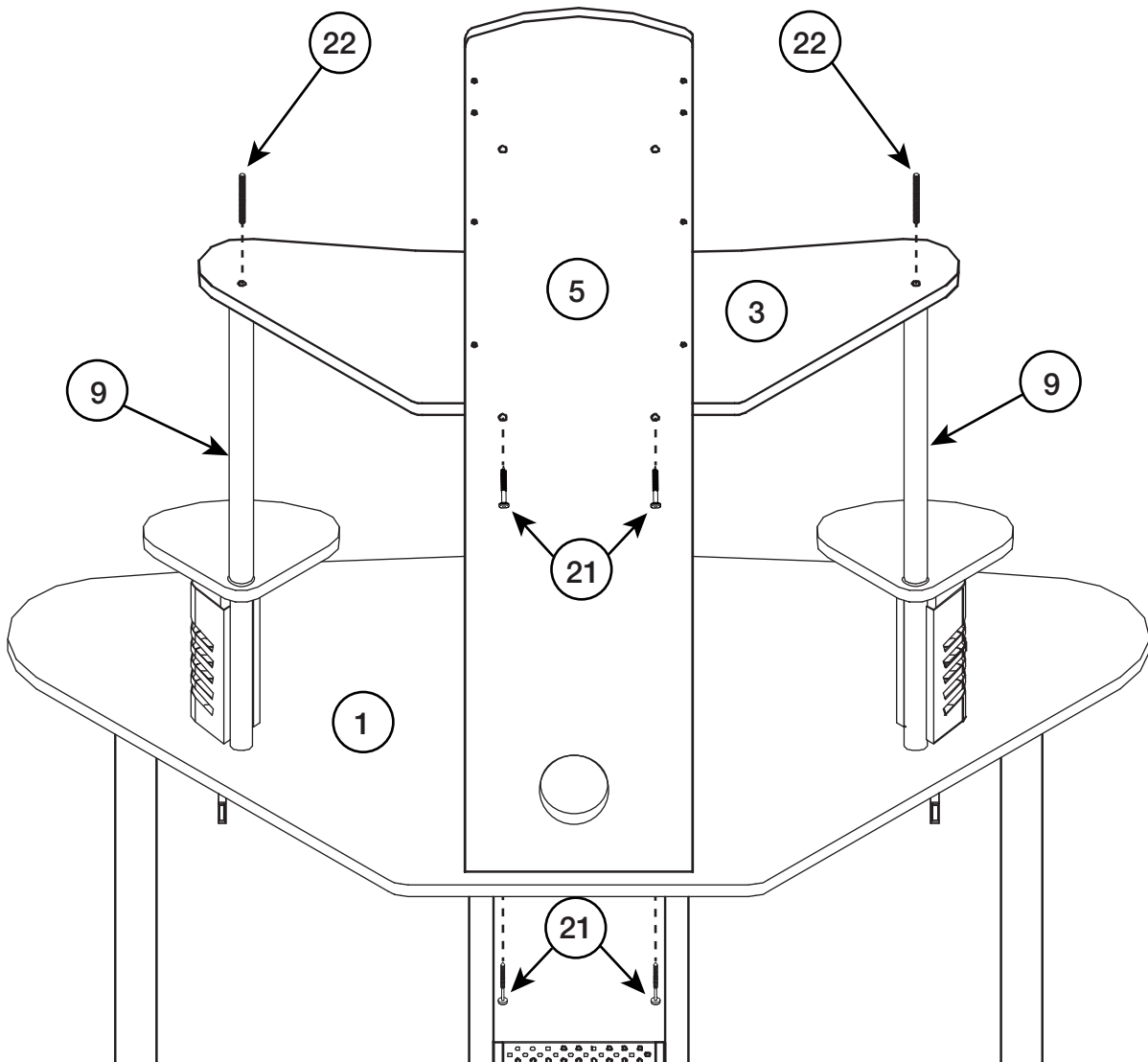

- Attach Rear Wood Panel (5) to Main Top (1) using Allen Screw (21).
- Attach Top Shelf (3) to Rear Wood Panel (5) and Lower Shelf Tube (9) using Allen Screw (21) and Connector Bolt - Large (22).

Step 5

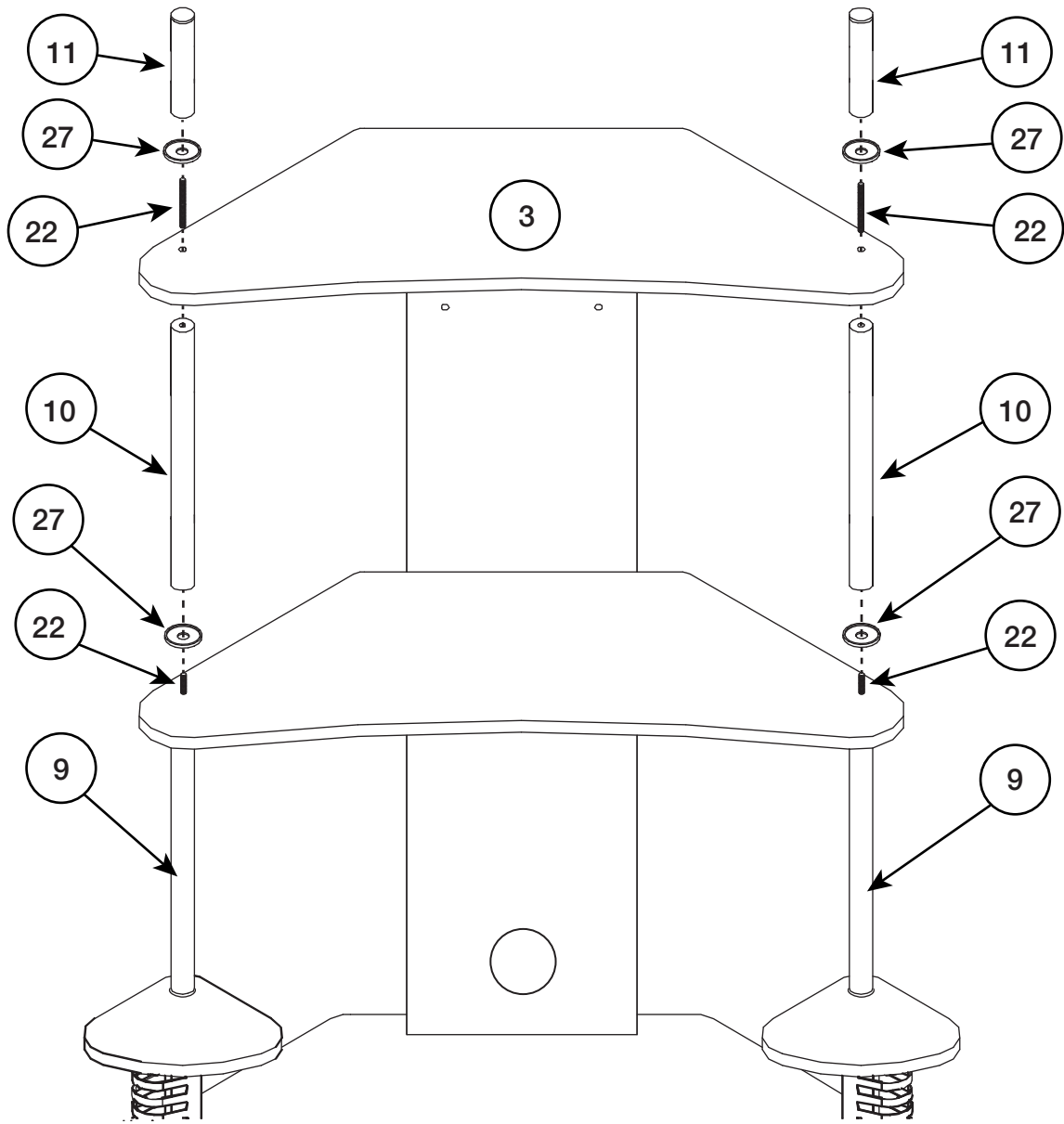

- Attach Upper Shelf Tube (10) and Plastic Spacer (27) to Connector Bolt - Large (22) already attached to Lower Shelf Tube (9).
- Attach Top Shelf (3) to Upper Shelf Tube (10) using Connector Bolt - Large (22), Top Tube (11) and Plastic Spacer (27).

Step 6

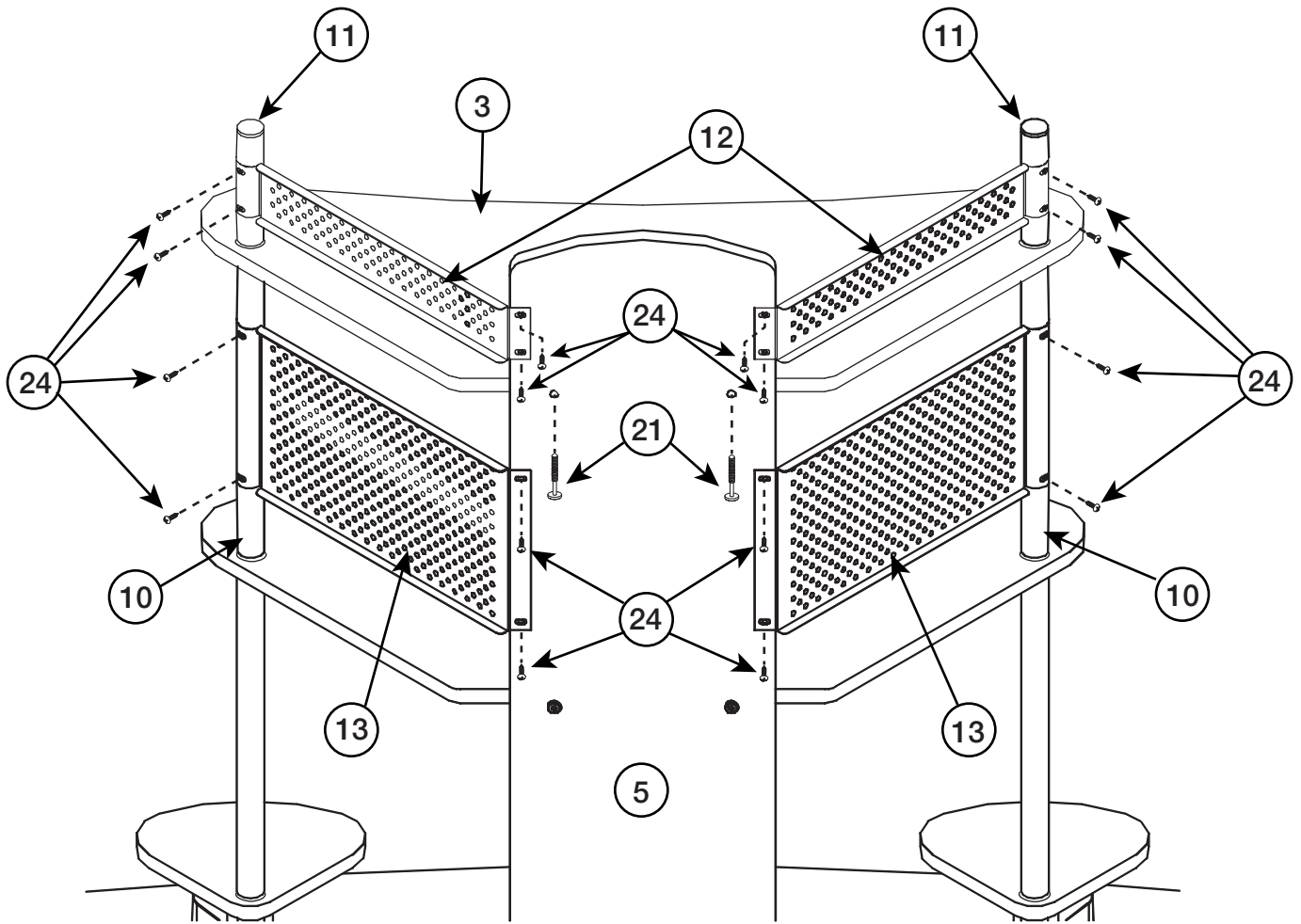

- Secure Top Shelf (3) to Rear Wood Panel (5) using Allen Screw (21).
- Attach Side Panel - Small (12) and Side Panel - Large (13) to Rear Wood Panel (5), Upper Shelf Tube (10) and Top Tube (11) using Philips Screw (24).

Step 7

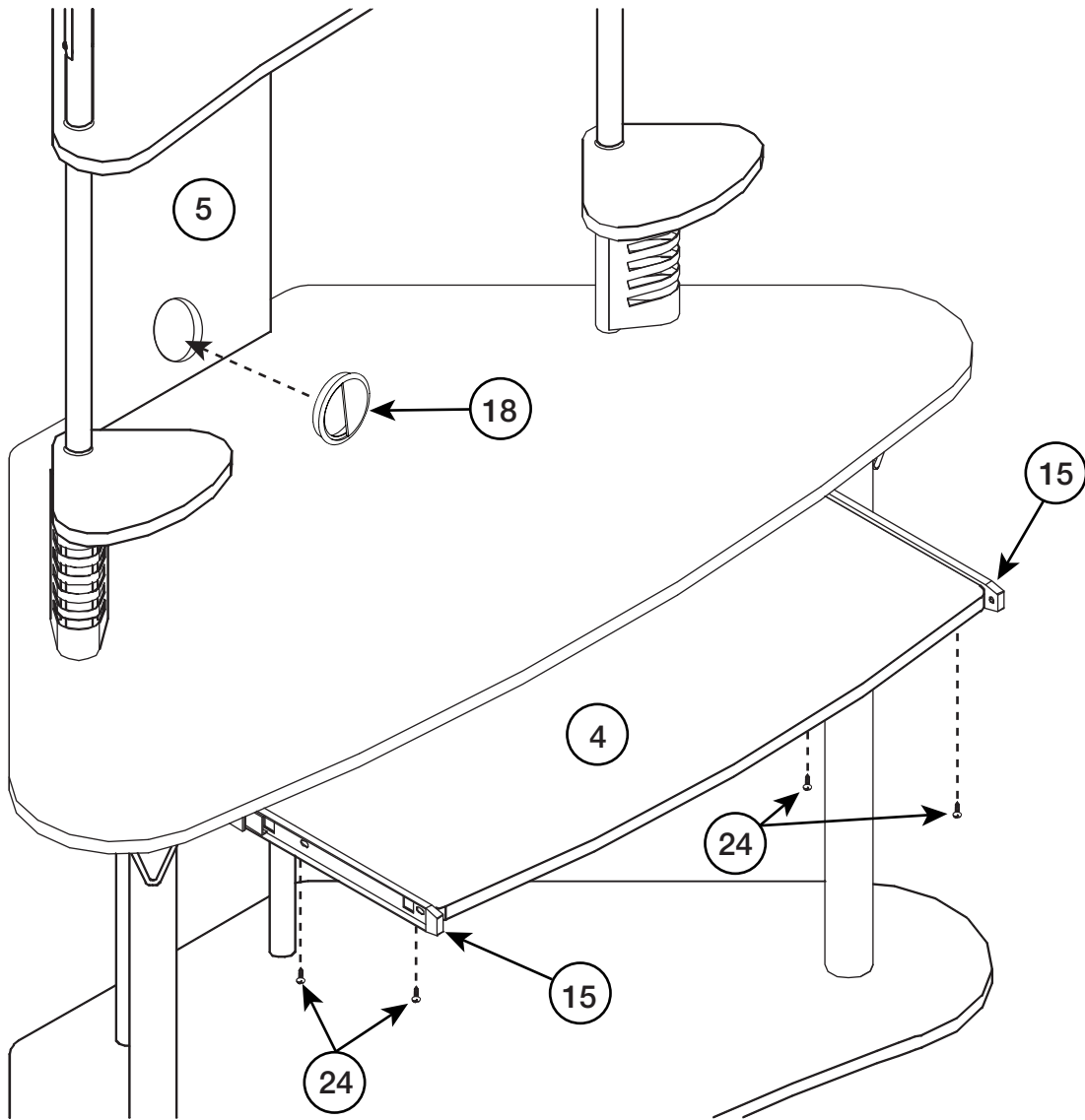

- Attach Keyboard Shelf (4) to Sliders (15) using Philips Screw (24).
- Insert Cable Collar (18) into hole in Rear Wood Panel (5).

LIMITED WARRANTY

Calico Designs (the “Company”) warrants to the original purchaser that this product will be free from defects in its workmanship and materials, under normal residential use and service conditions, as described herein. The Company will repair or replace, at its option, without charge to the original purchaser only, the defective product or parts for a period of ten (10) years or Thirty (30) days on closeouts and discounted products) from the date of purchase and while owned by the original purchaser. This warranty shall be effective for the applicable time period beginning from date of purchase as shown on your original sales receipt. Replacement parts can only be supplied if parts are available. Items out of production may be unavailable. The Company’s obligation under this warranty is limited to repairing or replacing products or parts as provided herein. This product has been designed for and is intended for residential use only. This warranty is original purchaser’s sole remedy for product defects, and this warranty does not extend to any product, or damage to any product, caused by or attributable to abuse or misuse, products used for commercial or rental purposes, use modification of, or attachments to the product, and products or parts not used, maintained, or installed in accordance with the Company’s installation, maintenance and/or applicable guidelines. The warranty extended hereunder is in lieu of any and all other warranties, express or implied, including without limitation any implied warranty of merchantability or of fitness for a particular purpose. The Company will not be responsible for indirect, special, incidental or consequential damages. Some states do not allow the exclusion or limitation of incidental or consequential damages, so the above limitations or exclusions may not apply to you. This warranty gives you specific legal rights. You may also have other rights which may vary from state to state. The Company will advise you of the procedure to follow in making warranty claims. Telephone Calico Designs at 866.942.0492 to explain the defect and give your name, address, and telephone number. Please be prepared with the model number of the product, date and place of purchase. If you require any assistance with assembly or parts please visit our website: www.calico-designs.com.

GARANTÍA LIMITADA

Calico Designs (la “Compañía”) garantiza al comprador original que este producto estará libre de defectos tanto de fabricación como en los materiales utilizados bajo el uso, servicio y condiciones normales residenciales, tal como se describe a continuación. La Compañía reparará o reemplazará, como una opción, sin cargo alguno únicamente al comprador original, el producto o las partes defectuosas por un período de diez (10) años o treinta (30) días si son productos de saldo y con descuento) desde la fecha de compra y mientras éste siga siendo propiedad del comprador original. Esta garantía será efectiva para el período de tiempo pertinente a partir de la fecha de compra que se muestra en el recibo de venta original. Las partes de reemplazo únicamente podrán ser proporcionadas si éstas se encuentran disponibles. Los artículos que estén descontinuados podrían no estar disponibles. La obligación de la Compañía bajo esta garantía se limita a la reparación o el reemplazo de los productos o las partes como se describe en ésta. Este producto ha sido diseñado para, y con el propósito de que sea para uso residencial únicamente. Esta garantía es el recurso exclusivo respecto a productos defectuosos para el comprador, y esta garantía no se extiende a cualquier otro producto, o los daños a cualquier otro producto, causados por, o atribuibles al abuso o mal uso, productos utilizados para propósitos comerciales o de arrendamiento, modificación en el uso de, o anexos al producto, y productos o partes que no sean usadas, mantenidas en buenas condiciones, o instaladas de acuerdo con las directrices de instalación y mantenimiento de la compañía, y/o otras directrices pertinentes. Conforme a la presente extensión de esta garantía, en vez de cualquier y todas las otras garantías, expresas o implícitas, incluyendo sin limitación cualquier garantía tácita de comercialidad o capacidad para un propósito particular. La Compañía no será responsable de los daños indirectos, especiales, incidentales o consecuentes. En algunos estados no se permite la exclusión o limitación de daños incidentales o consecuentes, por lo que las limitaciones o exclusiones anteriores podrían no ser aplicables para usted. Esta garantía le ofrece derechos legales específicos. Usted también podría tener otros derechos, los cuales podrían variar en cada estado. La Compañía le informará acerca del proceso a seguir para realizar los reclamos de esta garantía. Comuníquese con Calico Designs al 866.942.0492 para explicar el defecto y proporcione su nombre, dirección y número telefónico. Por favor esté listo para proporcionar la información del número de modelo del producto, la fecha y el lugar de compra. Si necesita ayuda para ensamblar o con las partes, por favor visite nuestro sitio en Internet: www.calico-designs.com.

GARANTIE LIMITÉE

Calico Designs (la « Compagnie ») garantit à l’acheteur original que ce produit sera exempt de tout défaut de fabrication et matériel s’il est utilisé à la maison et dans des conditions d’exploitation normales, tel que décrit à la présente. La Compagnie réparera ou remplacera, à sa discrétion et sans frais pour l’acheteur original seulement, le produit défectueux ou les pièces défectueuses pour une période de dix (10) ans ou trente (30) jours sur des produits liquidés ou offerts à prix réduits), à compter de la date d’achat et pendant que l’acheteur original est propriétaire du produit. Cette garantie sera en vigueur pour la période de temps applicable à compter de la date d’achat, comme l’illustre le reçu de vente original. Les pièces de rechange ne pourront être fournies uniquement si elles sont disponibles. Les articles hors de production ne seront peut-être pas disponibles. En vertu de cette garantie, l’obligation de la Compagnie se limite à réparer ou à remplacer les produits ou les pièces, comme le stipulent les présentes. Ce produit a été conçu pour un usage résidentiel et a pour but d’être utilisé uniquement ainsi. Cette garantie est le seul recours de l’acheteur original lorsque le produit est défectueux, et cette garantie ne s’applique pas à tout produit ou dommages à tout produit, causés par ou attribuables à un usage abusif ou à un mésusage ou si les produits sont utilisés à des fins commerciales ou de location, si l’utilisation du produit est modifiée ou si les accessoires et les produits ou pièces du produit ne sont pas utilisés, entretenus ou installés conformément aux directives d’installation, d’entretien et/ou applicables. La garantie fournie à la présente remplace toutes autres garanties expresse ou implicite, y compris sans toutefois s’y limiter toute garantie implicite de commercialité ou de qualité pour un usage particulier. La Compagnie n’est pas responsable des dommages indirects, spéciaux, imprévus ou consécutifs. Certains états ou provinces interdisent l’exclusion ou la restriction des dommages imprévus ou consécutifs; ainsi, les limites ci-dessus ou les exclusions ne s’appliquent peut-être pas. Cette garantie vous donne des droits spécifiques. Vous pourriez avoir d’autres droits qui peuvent varier d’un état à l’autre ou d’une province à l’autre. La Compagnie vous indiquera comment présenter des réclamations de garantie. Communiquez avec Calico Designs al 866.942.0492 pour expliquer la défectuosité, et donnez vos nom, adresse et numéro de téléphone. N’oubliez pas de donner le numéro de modèle du produit, la date et le lieu d’achat. Si vous avez besoin d’aide pour assembler le produit ou obtenir des pièces, consultez notre site web à l’adresse www.calico-designs.com.